

Delivering leading edge, innovative power solutions for more than 30 years....

Model:GTM96600-60VV.V-R2

August 9, 2022

## GTM96600-60VV.V-R2

### Information

Model Number	GTM96600-60VV.V-R2
Description	60 W, DoE Level VI, ErP, CoC V5 Tier 2 Efficiency, Hybrid Wall Plug in and Two Prong (C8) Inlet, Desktop Adapter, Ac-Dc Power Supply

### Model Picture



Agency Documents	<a href="http://www.globtek.info/certs/GTM96600-TZ/">http://www.globtek.info/certs/GTM96600-TZ/</a>
CE EC-Declaration	<a href="https://www.globtek.com/pdf/ec_declaration/a00a000000MmH0aEAF">https://www.globtek.com/pdf/ec_declaration/a00a000000MmH0aEAF</a>
RoHS/RoHS2 Declaration	<a href="https://www.globtek.com/pdf/rohs_cert/a00a000000MmH0aEAF">https://www.globtek.com/pdf/rohs_cert/a00a000000MmH0aEAF</a>
REACH Declaration	<a href="https://www.globtek.com/pdf/iso_certificates/REACH.pdf">https://www.globtek.com/pdf/iso_certificates/REACH.pdf</a>
Conflict Minerals Declaration	<a href="https://www.globtek.com/pdf/conflict-minerals.pdf">https://www.globtek.com/pdf/conflict-minerals.pdf</a>

Delivering leading edge, innovative power solutions for more than **30** years....

Model:GTM96600-60VV.V-R2

August 9, 2022

**MODEL PARAMETERS**

Type	Wall Plug-in+Desktop Combination
Technology	Regulated Switchmode AC-DC Power Supply AC Adaptor
Category	ICT / ITE / Medical Power Supply/Class 2/Household Power Supply
Input Voltage	100-240V~, 50-60 Hz
I/P Amps (A)	1.5 A
Wattage (W)	60.0
Vout Range (V)	5-54
Efficiency Level	USA DOE Level VI / Eco-design Directive 2009/125/EC, (EU) 2019/1782
Ingress Protection	IP40, IP54 Option available
Size (mm)	117.53*53.47*36.6

**PROPRIETARY INFORMATION**

PROPRIETARY OF GLOBTEK, INC. ANY REPRODUCTION, DISCLOSURE OR USE OF THIS DRAWING, IN WHOLE OR IN PART, IS HEREBY PROHIBITED EXCEPT AS SPECIFIED IN WRITING BY GLOBTEK, INC.

<https://www.globtek.com/datasheet/w71086>

Delivering leading edge, innovative power solutions for more than 30 years....

Model:GTM96600-60VV.V-R2

August 9, 2022

# ENCLOSURE

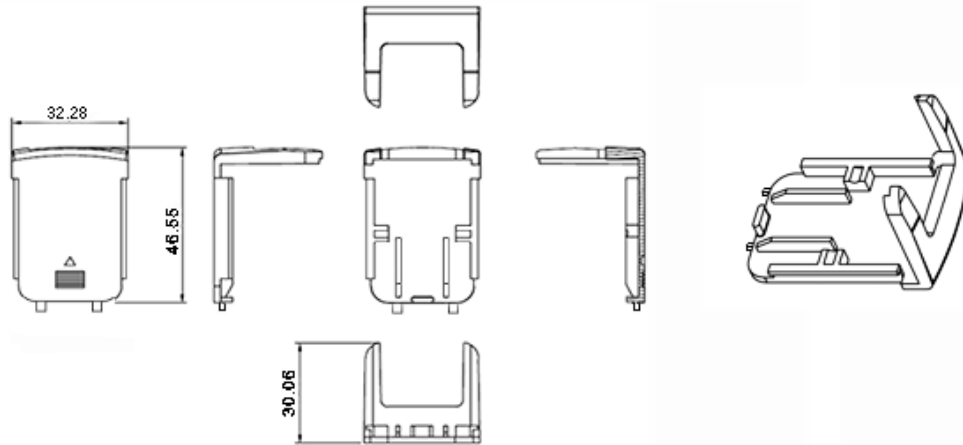
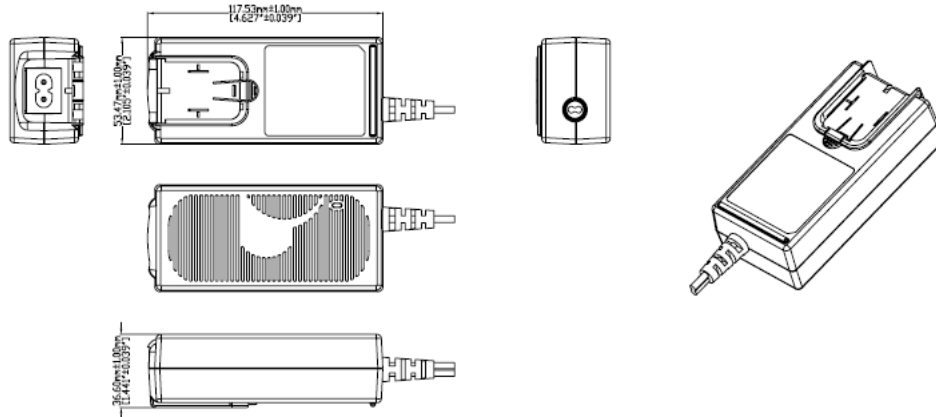

Unit shipped without an installed input plug.  
"Desktop insert" installed.

Delivering leading edge, innovative power solutions for more than **30** years....

Model:GTM96600-60VV.V-R2

August 9, 2022

**RATING TABLE**

Model Number	Voltage	Amps(A)	Watts(W)	RFQ
GTM96600-4005-R2	5 V	8	40.00	<a href="#">RFQ</a>
GTM96600-2505-R2	5 V	5	25.00	<a href="#">RFQ</a>
GTM96600-4005.95-R2	5.95 V	6.72	39.98	<a href="#">RFQ</a>
GTM96600-4507.5-R2	7.5 V	6	45.00	<a href="#">RFQ</a>
GTM96600-5409-R2	9 V	6	54.00	<a href="#">RFQ</a>
GTM96600-6012-R2	12 V	5	60.00	<a href="#">RFQ</a>
GTM96600-6015-1.2-R2	13.8 V	4.34	59.89	<a href="#">RFQ</a>
GTM96600-6015-R2	15 V	4	60.00	<a href="#">RFQ</a>
GTM96600-6024-8.0-R2	16 V	3.75	60.00	<a href="#">RFQ</a>
GTM96600-6018-R2	18 V	3.333	59.99	<a href="#">RFQ</a>
GTM96600-6019-R2	19 V	3.15	59.85	<a href="#">RFQ</a>
GTM96600-6020-R2	20 V	3	60.00	<a href="#">RFQ</a>
GTM96600-6024-R2	24 V	2.5	60.00	<a href="#">RFQ</a>
GTM96600-6028-R2	28 V	2.14	59.92	<a href="#">RFQ</a>
GTM96600-6030-R2	30 V	2	60.00	<a href="#">RFQ</a>
GTM96600-6037.5-R2	37.5 V	1.6	60.00	<a href="#">RFQ</a>
GTM96600-6048-R2	48 V	1.25	60.00	<a href="#">RFQ</a>
GTM96600-6054-R2	54 V	1.11	59.94	<a href="#">RFQ</a>

Model:GTM96600-60VV.V-R2

August 9, 2022

## SPECIFICATIONS

### Input

Input Voltage:	Specified: 90-264VAC, Nameplate: 100-240VAC 100% rated load current for 90-264VAC 85% rated load current for 85-264VAC 100% rated load current for 110-370VDC
Input Frequency:	Specified: 47-63Hz, Nameplate: 50-60Hz
No Load Input Power:	<75mW @ 230VAC (EU CoC Tier 2 compliant) for ≤ 49W rating <150mW @ 230VAC (EU CoC Tier 2 compliant) for > 49W rating
Inrush Current:	30A/60A max. (cold start @ 115V/230VAC)
Efficiency:	DoE Level VI and EU CoC Tier 2 compliant

### Output

Turn-on Delay:	1 second max. @ 115VAC and full load
Output Regulation:	± 5% (measured at output connector)
Line Regulation:	± 0.5% typ. (measured at output connector)
Ripple:	1% or 100mV, whichever is greater (using a 47µF low-ESR cap + 0.1µF ceramic capacitor, measured @ 20MHz BW, at output connector)
Transient Response:	5% max. deviation, 1ms typ. recovery time (with 40% to 70% load step)
Hold-up Time:	8ms typ. (nominal input voltage and full load)
Power Indicator:	Green LED

### Protections

Input Protection:	MOV transient suppressor, input line fusing
Over-Current Protection:	110 - 160% of rated output current, auto-restart, current limit range determined by normal output power rating, not de-rated power rating
Short-Circuit Protection:	Auto-restart
Over-Voltage Protection:	110 - 130%, latched off, cycle AC to reset
Over-Temperature Protection:	On-chip temperature sensor (integrated in primary-side switching controller), shut down at T <sub>j</sub> = ~140°C, latched off, cycle AC to reset

### Environmental

MTBF:	1,500,000 hours @ 25°C ambient, full load (Telcordia SR-332, Issue 3)
Operating Temperature:	-20°C to 40°C (full load)
Storage Temperature:	-30°C to 80°C
Humidity:	0% to 95% relative humidity, non-condensing
Altitude:	5000m

Delivering leading edge, innovative power solutions for more than 30 years....

Model:GTM96600-60VV.V-R2

August 9, 2022

Cooling:	Convection
RoHS:	Complies with EU 2011/65/EU and China SJ/T 11363-2006
Note 1:	Regarding operating temperature a. See below de-rating table for output power capability at alternate temperature b. Extended low-end temperature range available as a custom option

## Safety

Dielectric Withstand Voltage:	4000VAC or 5656VDC from input to output 3000VAC or 4242VDC from input to earth (Class I models only)
Touch Current:	Class I: 20 $\mu$ A max. Class II: 85 $\mu$ A max. Class II F2: 20 $\mu$ A max.
Earth Leakage Current	Class I: 300 $\mu$ A max. Class II: N/A
Means of Protection:	2 x MOPP
Output Isolation Options:	Class I: C6 or C14 inlet (output negative tied to Earth contact) Class II: C8 or C18 inlet Class II FE: C6 or C14 inlet (output isolated from Earth contact) Review isolation options by reading our white paper <a href="#">PSU Isolation and Identity</a> .
Earth Continuity Test:	< 0.1 $\Omega$ between earth pin (on AC inlet) and PCB termination point (Class I models only)
Compliant Standards:	See listing at end of this datasheet for specific standards

## EMC

Applicable Standards:	Medical: EN60601-1-2, 4th edition Emissions: EN55032, EN61000-6-3, EN61000-6-4, CISPR11, CISPR22 Immunity: EN55024, EN61000-6-1, EN61000-6-2
Conducted Emissions:	Class B, FCC Part 15, Class B (with resistive load)
Radiated Emissions:	Class B, FCC Part 15, Class B (with resistive load)
Harmonic Current Voltage Distortion:	EN61000-3-2, Class A
Voltage Fluctuations/Flicker:	EN61000-3-3
Electrostatic Discharge (ESD) Immunity:	EN61000-4-2, 10KV contact discharge, 20KV air discharge
Radiated RF Immunity:	EN61000-4-3, 10V/m 80-1000MHz, 3V/m 1-2.7GHz, 80% 1KHz AM
EFT/Burst Immunity:	EN61000-4-4, 4KV/100kHz.
Line Surge Immunity:	EN61000-4-5, 2KV differential, 4KV common-mode
Conducted RF Immunity:	EN61000-4-6, 3VRMS, 80% 1KHz AM
Power Frequency Magnetic Field Immunity:	EN61000-4-8, 3A/m
Voltage Dip Immunity:	EN61000-4-11

## Enclosure

Housing:	High impact plastic, 94V0 polycarbonate, non-vented Desktop: C6, C7, C14, or C18 inlet
----------	---

Delivering leading edge, innovative power solutions for more than 30 years....

Model:GTM96600-60VV.V-R2

August 9, 2022

AC Input Mechanical Options:	Hybrid: Desktop inlet or changeable blades for wall-plug-in style, Class I or Class II input
Markings:	Label and/or pad printed and/or laser-etched into case

## Special Options

1. Removal of LED (cost reduction or aesthetic purpose)
2. Custom cordsets, various cordage types, and connector types
3. Custom markings
4. Short term output surge capability for motors or other high peak current loads. (Available up to 120W for 1 second at nameplate voltage range. Higher levels possible for limited input voltage range, or larger allowed voltage dip.)
5. Reduced leakage current
6. Tightened output voltage tolerance
7. Reduced output ripple level
8. Reduced output power rating
9. High reliability PCB laminate with plated through-holes for IPC610 Class 2 compliance
10. Low temperature option, down to -40°C
11. Special housing and cordset colors
12. "Back EMF" upgrade, for motor loads and other high inductance applications with reverse energy flow requirements
13. Improved ingress protection (IP) rating

## Output Connectors

- Several output connector options are available with various output current ratings. GlobTek can supply 10A rated 2.1mm and 2.5mm style DC Power Jacks, to complement our 10A output rated 2.1mm and 2.5mm DC power plugs used on our output cordsets.
- Please visit our real-time listing of mating connector product offering:  
<https://en.globtek.com/news/high-current-coaxial-barrel-plug-jacks-for-high-wattage-power-supplies>

Delivering leading edge, innovative power solutions for more than 30 years....

Model:GTM96600-60VV.V-R2

August 9, 2022

# DERATING CURVE

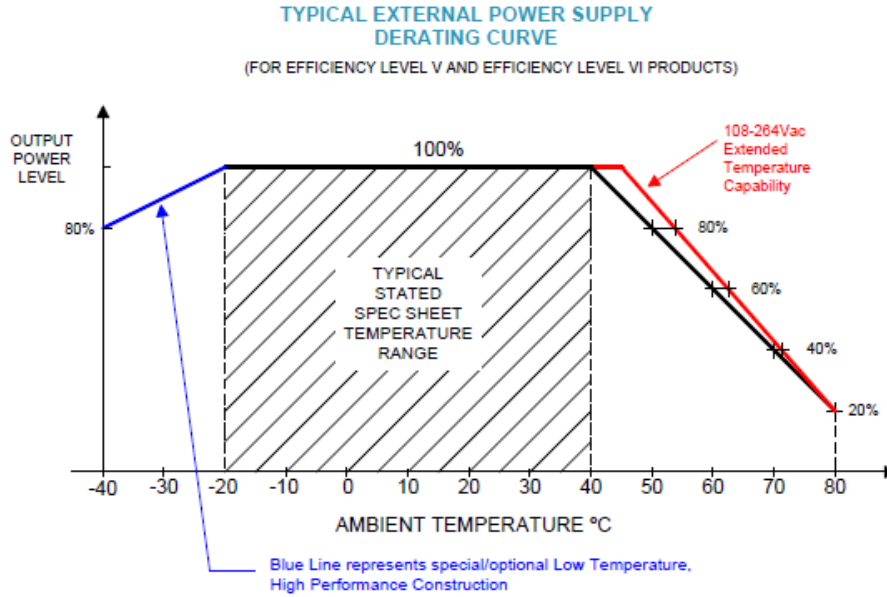



Delivering leading edge, innovative power solutions for more than 30 years....

Model:GTM96600-60VV.V-R2

August 9, 2022

**INPUT CONFIGURATION**

Description IEC 60320/C8 AC Inlet connector

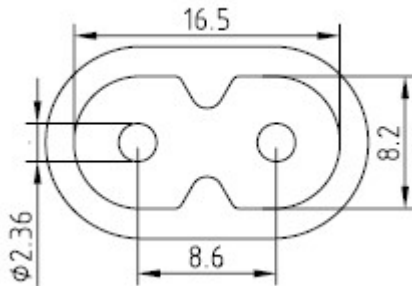
[Blade Insertion Instructions](#)  
[R-Blade Style Instruction Video](#)

Mates with IEC 60320/C8 Plug

This series of Interchangeable Blade products may be used with Proprietary Interchangeable Blades as described below or with standard international power cords.

Optional INPUT BLADES: R-Socket: below are available blades configurations which are "not included" (unless stated above); may be purchased separately, packaged with power supply, or as a separate "R-KIT" if specified

# Part Number	Main Country/Region	Plug	IECEE Type
1 <a href="#">R-NA-2(R)</a>	North America, Japan	Nema 1-15P	Type A
2 <a href="#">R-SAA-2(R)</a>	Australia/New Zealand	AS/NZ 3112	Type I
3 <a href="#">R-UK-2(R)</a>	United Kingdom/Ireland	UK, Hong Kong, Singapore, Gulf States	Type G
4 <a href="#">R-EU-2(R)</a>	Europe	CEE 7/16	Type C
5 <a href="#">R-CN-2(R)</a>	China	GB 2099	Type A
6 <a href="#">461-03030003(R)</a>	N/A	<a href="#">R-DI(R) Desktop Insert for use with a cord</a>	N/A
7 <a href="#">R-KIT-2(R)</a>	prepackaged kit	1,2,3,4 above	N/A
8 <a href="#">R-KIT-2-INTL(R)</a>	prepackaged kit	2,3,4 above	N/A

Delivering leading edge, innovative power solutions for more than 30 years....

Model:GTM96600-60VV.V-R2

August 9, 2022

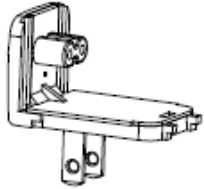

### UL 2P

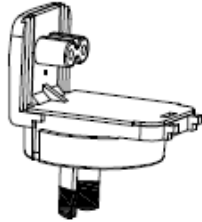
 P/N: R-NA-2(R)  
 NORTH AMERICA  
 JAPAN

### AUS 2P

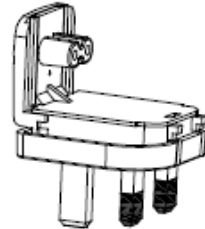
 P/N: R-SAA-2(R)  
 AUSTRALIA

### UK 2P

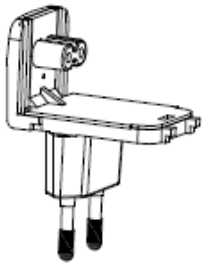
 P/N: R-UK-2(R)  
 UNITED KINGDOM  
 HONG KONG  
 SINGAPORE

### EU 2P

 P/N: R-EU-2(R)  
 EUROPE  
 SOUTH AMERICA

### CN 2P

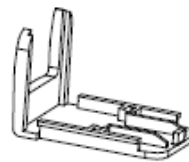
 P/N: R-CN-2(R)  
 CHINA

### R-DI

 P/N: R-DI  
 DESKTOP INSERT

#### Standard Cordsets

Below are standard cordsets which are "not included" (unless stated above); these may be purchased separately or packaged with the power supply. Contact your Sales Engineer if the style required is not shown below. Many more available in different lengths, colors or cable material.

#### [Standard International IEC 320/C7 Cordsets](#)

Part Number	Country	Plug	Connector	Length (mm)	Length (feet)
<u><a href="#">2094112M703(R)</a></u>	Argentina (Type I)	IRAM 2063	IEC 320/C7	2000	7
<u><a href="#">5014112M703A(R)</a></u>	Australian (Type I)	AS 3112	IEC 320/C7	2000	7

Delivering leading edge, innovative power solutions for more than **30** years....

Model:GTM96600-60VV.V-R2

August 9, 2022

<a href="#">207B4111M8703(R)</a>	Brazil (Type N)	NBR14136	IEC 320/C7	1800	6
<a href="#">4533501M8703(R)</a>	China (Type A)	GB 2099.1	IEC 320/C7	1830	6
<a href="#">2074112M703A(R)</a>	European (Type C)	CEE 7/16	IEC 320/C7	2000	7
<a href="#">2084111M8703(R)</a>	South Africa (Type M)	BS 546	IEC 320/C7	1800	6
2084111M8703B(R)	India (Type D)	ISI:1293	IEC 320/C7	1800	6
<a href="#">2714111M8703A(R)</a>	India (Type C)	ISI:1293	IEC 320/C7	1800	6
<a href="#">451J3401M8703(R)</a>	Japan (Type A)	JIS 8303	IEC 320/C7	1830	6
<a href="#">2044112M703A(R)</a>	Korea (Type C)	KS C8305	IEC 320/C7	2000	7
<a href="#">4511116F703A(R)</a>	N. American (Type A)	NEMA 1-15P	IEC 320/C7	1830	6
<a href="#">4033401M8703A(R)</a>	Taiwan (Type A)	CNS690	IEC 320/C7	1830	6
<a href="#">6104112M703A(R)</a>	UK, Hong Kong, Singapore, Gulf States (Type G)	BS1363	IEC 320/C7	2000	7

Delivering leading edge, innovative power solutions for more than 30 years....

Model:GTM96600-60VV.V-R2

August 9, 2022

**OUTPUT CONFIGURATION**

Common output connector options:

 L Type (Coaxial  
5.5x2.5mm plug)

 C Type (Coaxial  
5.5x2.1mm plug)

 K Type (Coaxial  
3.5x1.3mm plug)

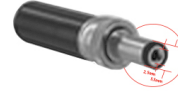
 LL Type (5.5x2.5mm  
Locking 760k type)

 CL Type (5.5x2.1mm  
Locking S761k type)

 ML2 Type (Molex  
housing 43025-0200)

 YL3 Type  
(KPPX-3P)

YL4 Type (KPPX-4P)

 EJ1/2/3/4/5 (EIAJ  
RC-5320A type  
connectors)

 MSB Type (Micro  
USB)

 USBC Type (USB  
Type C)

 Inquire for custom  
design

 For a comprehensive list of options, [click here](#)





Contact GlobTek for your specific requirements or custom solutions.

Delivering leading edge, innovative power solutions for more than **30** years....

Model:GTM96600-60VV.V-R2

August 9, 2022







## Approvals

Logo	Description
No Logo Applicable	EU 230V CoC Tier 2, 278/2009, Mar 2014
	Book 60335 up to 36 Volts
	Taiwan BSMI GTM96600-R2 T2 R32282 GTM96600-6048-R2; <a href="http://www.bsmi.gov.tw/wSite/ct?xItem=4072&amp;ctNode=8167=2">http://www.bsmi.gov.tw/wSite/ct?xItem=4072&amp;ctNode=8167=2</a>
No Logo Applicable	CB for IEC 60335-1:2010+A1
No Logo Applicable	IEC 60601-1:2005+A1 IEC 60601-1-11:2015
No Logo Applicable	CB for IEC 60950-1:2005+A1+A2
No Logo Applicable	IEC 61558-1:2005+A1, IEC 61558-2-16:2009+A1
No Logo Applicable	CB for IEC 62368-1:2014 (Second Edition)
 5000	CCC Altitude up to 5000 m GB17625.1-2012, GB4943.1-2011, GB/T9254-2008
	Test standard: EN 55032:2012+AC:2013 EN 61000-3-2:2014

Delivering leading edge, innovative power solutions for more than 30 years....

Model:GTM96600-60VV.V-R2







August 9, 2022

	EN 61000-3-3:2013 EN 55024:2010 EN 60601-1-2:2015
	Audio/Video, Information And Communication Technology Equipment - Part 1: Safety Requirements [UL 62368-1:2014 Ed.2] Audio/Video, Information And Communication Technology Equipment - Part 1: Safety Requirements [CSA C22.2#62368-1:2014 Ed.2]
	CHINA SJ/T 11364-2014, China RoHS Chart: <a href="http://en.globtek.com/globtek-rohs.php">http://en.globtek.com/globtek-rohs.php</a>
Conforms to AAMI STD.ES60601-1,IEC 60601-1-11 Certified to CAN/CSA STD.C22.2 NO.60601-1	Conforms to AAMI STD.ES60601-1,IEC 60601-1-11 Certified to CAN/CSA STD.C22.2 NO.60601-1
Conforms to UL STD. 1310 Certified to CSA STD. C22.2 NO.223	Conforms to UL STD. 1310 Certified to CSA STD. C22.2 NO.223
Conforms to UL STD. 60950-1 Certified to CSA STD C22.2 NO.60950-1	Conforms to UL STD. 60950-1 Certified to CSA STD C22.2 NO.60950-1
Conforms to UL STD. 62368-1 Certified to CSA STD C22.2 NO.62368-1	Conforms to UL STD. 62368-1 Certified to CSA STD C22.2 NO.62368-1
	
	Declaration ДС № EAЭC N RU Д-US.KA01.B.10453_19 Custom Union of Russia, Belarus and Kazakhstan <a href="http://www.globtek.com/redirect/?loc=gost-certificate-eac-declaration">http://www.globtek.com/redirect/?loc=gost-certificate-eac-declaration</a>
	Medical Electrical Equipment - Part 1: General Requirements For Basic Safety And Essential Performance [AAMI ES60601-1:2005 +A1]
	Information Technology Equipment Safety Part 1: General Requirements >Valid without technical revision:01Jan2022< [UL 60950-1:2007 Ed.2 +R:14Oct2014

Delivering leading edge, innovative power solutions for more than 30 years....

Model:GTM96600-60VV.V-R2







August 9, 2022

 Intertek Class 2 Power Unit	Class 2 Power Units [UL 1310:2011 Ed.6 +R:12Dec2014] Power Supplies With Extra-Low Voltage Class 2 Outputs [CSA C22.2 No.223:2015 Ed.3] up to 5A
IS 13252 (Part 1) IEC 60950-1  R-41017175 www.bis.gov.in	Bureau Of Indian Standards for GTM96600-4005-R2, GTM96600-4005-T2, GTM96600-6012-T2, GTM96600-6012-R2, GTM96600-6015-T2, GTM96600-6015-R2, GTM96600-6024-T2, GTM96600-6024-R2, GTM96600-6048-R2,,GTM96600-6026-P2
	Indoor Use Only - Mark is on the label or Molded in the case
 GlobTek, Inc.	JAPAN TUV R-PSE, Cert. No. JD 50313287, to J60950-1(H26) , J55022(H22),J3000(H25)[DC15?30V]. Please reference the following website for guidelines on PSE regulations: <a href="http://en.globtek.com/importing-ite-and-medical-power-supplies-ac-adaptors-to-japan/">http://en.globtek.com/importing-ite-and-medical-power-supplies-ac-adaptors-to-japan/</a>
 GlobTek, Inc.	JAPAN TUV R-PSE, Cert. No. JD 50313287, to J60950-1(H26) , J55022(H22),J3000(H25)[DC30?60V]. Please reference the following website for guidelines on PSE regulations: <a href="http://en.globtek.com/importing-ite-and-medical-power-supplies-ac-adaptors-to-japan/">http://en.globtek.com/importing-ite-and-medical-power-supplies-ac-adaptors-to-japan/</a>
 GlobTek, Inc.	JAPAN TUV R-PSE, Cert. No. JD 50469658, to J62368-1(H30) , J55032(H29),J3000(H25)[15V or less]. Please reference the following website for guidelines on PSE regulations: <a href="http://en.globtek.com/importing-ite-and-medical-power-supplies-ac-adaptors-to-japan/">http://en.globtek.com/importing-ite-and-medical-power-supplies-ac-adaptors-to-japan/</a>
 직류전원장치 AC/DC ADAPTER KTC HU10499-19039A 전기용품안전관리법에 의한 표시 최저소비효율기준 만족 제품 모델명: GTM96600-6554-T2, R2 Mfr. Name: GLOBTEK (SUZHOU) CO.,LTD A/S Center:10-6221-6100	Korea HU10499-19039A (for GTM96600-6x48-T2,R2(41V-54V))

Delivering leading edge, innovative power solutions for more than 30 years....

Model:GTM96600-60VV.V-R2

August 9, 2022





 <p>직류전원장치 AC/DC ADAPTER KTC HU10499-20044A R-R-G5Z-0008 전기용품안전관리법에 의한 표시 최저소비효율기준 만족 제품 모델명:GTM96600-6012-R2 Mfr. Name: GLOBTEK (SUZHOU) CO.,LTD A/S Center:10-6221-6100</p>	<p>Korea HU10499-20044A (for GTM96600-6x12-T2(A),R2 9-15V)</p>
<p>EFFICIENCY LEVEL </p>	<p>Efficiency: complies to section 301 of Energy Independence and Security Act (EISA) complies with Energy Star tier 2 (North America), ECP tier 2 (China), MEPS tier 2 (Australia), Code of Conduct (Europe)</p>
<p>LPS</p>	<p>Limited Power Source 60950</p>
	<p>Morocco SDoC declaration <a href="http://www.globtek.info/certs/Morocco%20SDoC%20Declaration/">http://www.globtek.info/certs/Morocco%20SDoC%20Declaration/</a></p>
 <p>Energy Verified Rendement Énergétique Vérifié</p>	<p>Canadian Energy Efficiency Regulations incorporating amendments 1 (only for model GTM96600-4005 only)</p>
	<p>RCM certificate ; Australia and New Zealand Regulatory Compliance, Mark ( <a href="http://rcm.standards.org.au/rcmfaq/rcmfaq.htm">http://rcm.standards.org.au/rcmfaq/rcmfaq.htm</a></p>
<p>RoHS</p>	<p>Specifications of directive 2011/65/EU Annex VI (ROHS-2) with amendment 2015/863-EU (ROHS-3) <a href="http://www.ce-mark.com/Rohs%20final.pdf">http://www.ce-mark.com/Rohs%20final.pdf</a></p>
	<p>S-Mark Certificate EN 60601-1:2006+A1+A12, EN 60601-1-11:2015</p>
	<p>S-Mark Certificate EN 60950-1:2006 + A11:2009 + A1:2010 + A12:2011+A2:2013 ( <a href="http://www.intertek.com/marks/s/">http://www.intertek.com/marks/s/</a>)</p>
<p>No Logo</p>	<p>South Africa approval to SANS IEC 60950</p>
<p>No Logo</p>	<p>No Logo</p>



Delivering leading edge, innovative power solutions for more than **30** years....

Model:GTM96600-60VV.V-R2

August 9, 2022

	UKCA Certification
 10276	Ukraine UKRSepro (Document: <a href="http://www.globtek.com/html/iso_certificates/GT_Ukraine.pdf">www.globtek.com/html/iso_certificates/GT_Ukraine.pdf</a> )
DO NOT REMOVE THE TAG WARNING/ADVERTISEMENT RISK OF ELECTRIC SHOCK DRY LOCATION USE ONLY FOR INDOOR USE ONLY Risque de choc électrique Utilisation endroit sec Pour une utilisation en intérieur See instructions if the input plug does not fit the power outlet	UL1310 Warning Label Up To 36 Volts with plugs
	Japan: Voluntary Control Council for Interference (VCCI)
	WEEE: Complies with EU 2012/19/EU ( <a href="http://ec.europa.eu/environment/waste/weee/index_en.htm">http://ec.europa.eu/environment/waste/weee/index_en.htm</a> ) Mark is on the label or Molded in the case