

Delivering leading edge, innovative power solutions for more than 30 years....

Model:GTM962252PWWWWV.V-F

June 2, 2020

GTM962252PWWWWV.V-F

Information

Model Number	GTM962252PWWWWV.V-F
Description	GTM962252PWWWWV.V-F, ITE / Medical Power Supply, 60601-1-4th Ed. , Open Frame/Internal, Regulated Switchmode AC-DC Power Supply AC Adaptor, Forced airflow for full rated power (CFM): 10CFM, Input Rating: 100-240V~, 50-60 Hz, , Output Rating: 225 Watts, Power rating with convection cooling (W) 140, 12-54V in 0.1V increments, Approvals: China RoHS; EAC; Level VI; RoHS; Ukraine; VCCI; WEEE;

Model Picture

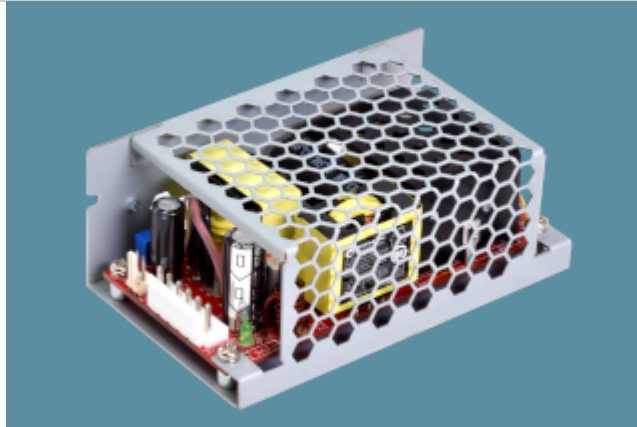

Agency Documents

CE EC-Declaration	https://www.globtek.com/pdf/ec_declaration/a003a00000M4jYYEAZ
RoHS/RoHS2 Declaration	https://www.globtek.com/pdf/rohs_cert/a003a00000M4jYYEAZ
REACH Declaration	https://www.globtek.com/pdf/iso_certificates/REACH.pdf
Conflict Minerals Declaration	https://www.globtek.com/pdf/conflict-minerals.pdf

Delivering leading edge, innovative power solutions for more than **30** years....

Model:GTM962252PWWWV.V-F

June 2, 2020

MODEL PARAMETERS

Type	Open Frame/Internal
Technology	Regulated Switchmode AC-DC Power Supply AC Adaptor
Category	ITE / Medical Power Supply
Input Voltage	100-240V~, 50-60 Hz
I/P Amps (A)	3A
Wattage (W)	225.0
Vout Range (V)	12-54
Efficiency Level	USA DOE Level VI / Eco-design Directive 2009/125/EC, (EU) 2019/1782
Ingress Protection	na
Size (mm)	103.5 (L) x 62.3 (W) x 40.0 (H)

Delivering leading edge, innovative power solutions for more than 30 years....

Model:GTM962252PWWWVV.V-F

June 2, 2020

ENCLOSURE

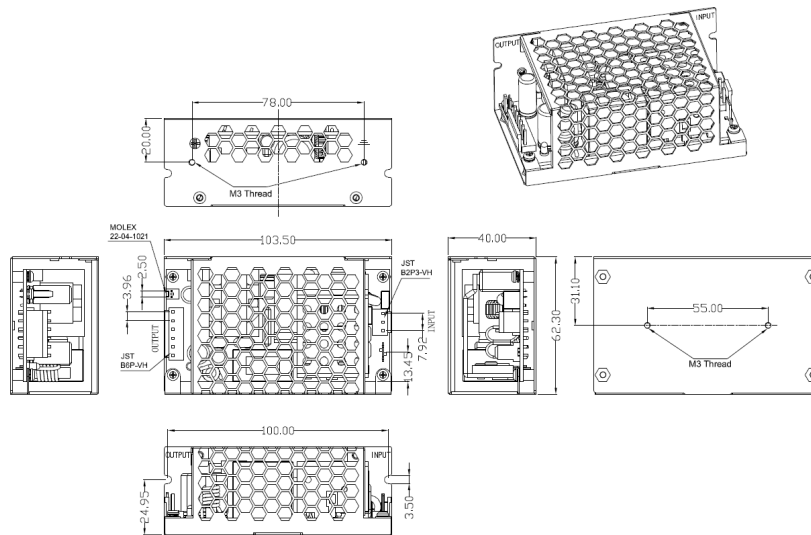
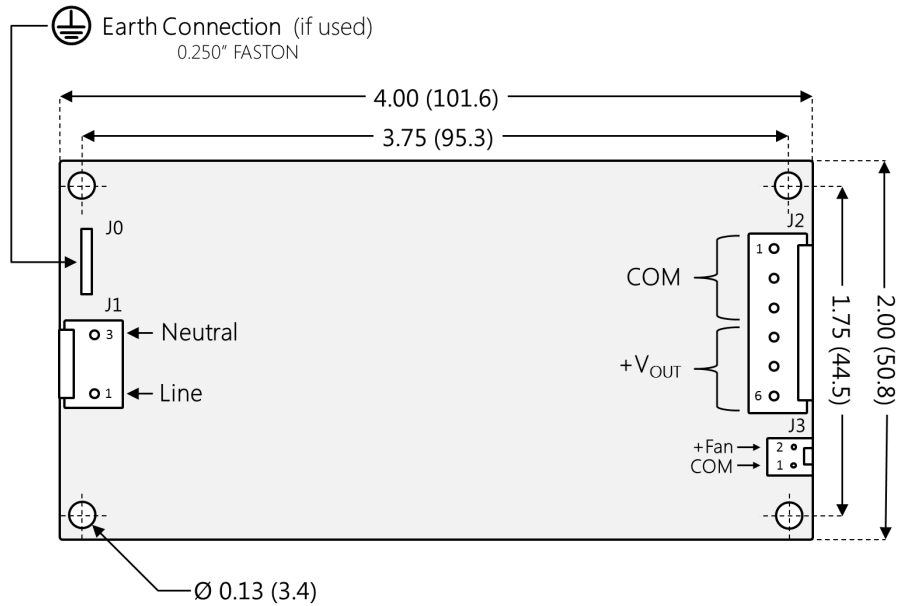

Customer may need to provide EMI shielding if not in metal chassis

Dimensions for larger alternate 3x5 product are below

Delivering leading edge, innovative power solutions for more than **30** years....

Model:GTM962252PWWWV.V-F

June 2, 2020

RATING TABLE

Model Number	Voltage	Amps(A)	Watts(W)	RFQ
GTM962252P22512A-F	12 V	18.75	225.00	RFQ
GTM962252P22515A-F	15 V	15	225.00	RFQ
GTM962252P22516A-F	16 V	14.06	224.96	RFQ
GTM962252P22516-F	16 V	14.06	224.96	RFQ
GTM962252P22518A-F	18 V	12.5	225.00	RFQ
GTM962252P22518-F	18 V	12.5	225.00	RFQ
GTM962252P22519A-F	19 V	11.84	224.96	RFQ
GTM9622502P22524A-F	24 V	9.37	224.88	RFQ
GTM962252P22530A-F	30 V	7.5	225.00	RFQ
GTM962252P22536-F	36 V	6.25	225.00	RFQ
GTM962252P22536A-F	36 V	6.25	225.00	RFQ
GTM962252P22538A-F	38 V	5.92	224.96	RFQ
GTM962252P22548A-F	48 V	4.69	225.12	RFQ
GTM962252P22554A-F	54 V	4.17	225.18	RFQ

Delivering leading edge, innovative power solutions for more than 30 years....

Model:GTM962252PWWWVV.V-F

June 2, 2020

SPECIFICATIONS

Features

- High power density 2" x 4" format (3" x 5" and 4.22" x 7" formats also available)
- 2" x 4" version available in L-frame, cage, and potted configurations
- Low conducted & radiated EMI: Class B without external filters, ferrites, or metal planes (all input configurations)
- Class I, Class II, or Class II with Functional Earth input configurations
- ITE/ICT and medical (2 x MOPP) certified (suitable for Type-B or Type-BF applications)
- Auxiliary +12V fan output

Input

Input Voltage:	Specified: 85-264VAC, Nameplate: 100-240VAC
Input Frequency:	Specified: 47-63Hz, Nameplate: 50-60Hz
Input Current:	2.75A typ. @ 90VAC, 1.0A typ. @ 230VAC (full load)
No Load Input Power:	<150mW
Inrush Current:	<75A @ 230VAC (cold start @ 25°C)
Efficiency:	90 - 95% typ. (full load)
Power Factor:	>0.95 @ 115VAC, >0.90 @ 230VAC, 225W output >0.90 @ 115VAC, >0.85 @ 230VAC, 100W output

Output

Output Power:	225W (10CFM forced air) 140W (natural convection) Ratings are inclusive of fan output power Potted configuration is rated for 140W continuous with a 5 second 225W momentary surge capability
Turn-on Delay:	< 1 second @ 90VAC
Output Voltage Tolerance:	± 2.0% (worst case, set point + load/line regulation)
Load Regulation:	± 0.5% (measured at connector)
Line Regulation:	± 0.2% (measured at connector)
Ripple:	1% pk-pk (using a 47µF low-ESR cap + 0.1µF ceramic capacitor, measured @ 20MHz BW)
Transient Response:	<5% deviation (with 25% load step), recovery to within 1% in 1ms
Startup Overshoot:	<5% (full load)
Hold-up Time:	10ms min. (full load)
Fan Output Power:	1.2A (10CFM forced air) 0.8A (natural convection) 12V nominal

Delivering leading edge, innovative power solutions for more than 30 years....

Model:GTM962252PWWWVV.V-F

June 2, 2020

Fan Output Voltage:	Actual ranges (typ.) for 15% to 100% main output load conditions: 12V: Same as main output 15V: 10-13V 19V, 24V, 30V, 38V, 48V, 54V: 11-14V
Output Indicator:	Green LED
Protections	
Input Protection:	MOV transient suppressor, dual fuses (line + neutral)
Over-Voltage Protection:	110-130%. Latched-off, cycle AC to reset
Over-Current Protection:	130% typ. Non-latched with auto-recovery
Short Circuit Protection:	Non-latched with auto-recovery
Over-Temperature Protection:	Latched-off, cycle AC to reset
Environmental	
MTBF:	1,500,000 hours @ 25°C ambient, full load (Telcordia SR-332, Issue 3)
Operating Temperature:	-20°C to 50°C (full output power), -25°C to 80°C (derated)
Storage Temperature:	-30°C to 85°C
Humidity:	0% to 95% relative humidity, non-condensing
Altitude:	5000m max.
Vibration:	Conforms to EN60068-2-6
Safety	
Dielectric Withstand Voltage:	4000VAC or 5656VDC from input to output 3000VAC or 4242VDC from input to earth
Intended Medical Application:	Type-B or Type-BF
Touch Current:	3-conductor input - NC: <25µA, SFC: <200µA 2-conductor input - NC: <65µA, SFC: <140µA
Earth Leakage Current	3-conductor input: <200µA 2-conductor input: N/A
Means of Protection:	2 x MOPP
Primary-Secondary Bridging Capacitance:	Two IEC60384-14 certified Y1 capacitors in series
EMC	
Applicable Standards:	Medical: EN60601-1-2, 4th edition Emissions: EN55032, EN 55011, EN61000-6-3, EN61000-6-4, CISPR11/CISPR22 Immunity: EN55024, EN61000-6-1, EN61000-6-2
Conducted Emissions:	Class B, FCC Part 15, Class B (with resistive load)
Radiated Emissions:	Class B, FCC Part 15, Class B (with resistive load)
Harmonic Current Voltage Distortion:	EN61000-3-2, Class A

Delivering leading edge, innovative power solutions for more than 30 years....

Model:GTM962252PWWWV.V-F

June 2, 2020

Voltage Fluctuations/Flicker:	EN61000-3-3
Electrostatic Discharge (ESD) Immunity:	EN61000-4-2, 10KV contact discharge, 20KV air discharge (applied to input or output terminals)
Radiated RF Immunity:	EN61000-4-3, 20V/m 80-2700MHz, 80% 1KHz AM, 80% 5Hz AM
EFT/Burst Immunity:	EN61000-4-4, 4KV/100kHz.
Line Surge Immunity:	EN61000-4-5, 2KV differential, 4KV common-mode
Conducted RF Immunity:	EN61000-4-6, 3VRMS, (6VRMS in ISM/amateur bands), 80% 1KHz AM
Power Frequency Magnetic Field Immunity:	EN61000-4-8, 30A/m
Voltage Dip Immunity:	EN61000-4-11

Mechanical Formats

	Open-frame
GTM962250P:	No suffix: 2" x 4" style, 101.6*50.8*30.0mm, 170g -C suffix: 3" x 5" style, 127.0*64.8*30.0mm, 180g -D suffix: 4.22" x 7" style, 177.8*107.2*30.0mm, 190g
GTM962251P:	L-frame: 103.5*62.3*40.0mm, 230g
GTM962252P:	Cage: 103.5*62.3*40.0mm, 250g
GTM962253P:	Potted: 147.0*57.3*39.0mm, 500g
Note 1:	The open-frame format meets the above EMC specifications as a standalone unit. However, an L-frame or cage version may help to further improve EMI performance, or to help address other system level electrical/mechanical requirements.

Input/Output Connectors

Earth Terminal (J0):	Connector on PCB: Kang Yang PCH250 (0.250" x 0.031" Faston) Recommended mate: TE Connectivity/AMP 2-520184-2 Note: Leave earth terminal disconnected for Class II input
Input Connector (J1):	Connector on PCB: JST B2P3-VH Pin 1: Line, Pin 2: Not used, Pin 3: Neutral Recommended mate: JST VAR-2 (housing), JST SVA-41T-P1.1 (terminals)
Main Output Connector (J2):	Connector on PCB: JST B6P-VH Pin 1: COM, Pin 2: COM, Pin 3: COM, Pin 4: +VOUT, Pin 5: +VOUT, Pin 6: +VOUT Recommended mate: JST VHR-6N (housing), JST SVH-21T-P1.1 (terminals)
Fan Output Connector (J3):	Connector on PCB: Molex 22-04-1021 Pin 1: -FAN, Pin 2: +FAN Recommended mate: Molex 22-01-1022 (housing), Molex 2759 (terminals)

Special Options

- Custom labels/markings
- Short term output surge capability up to 350W
- Reduced touch current
- Reduced output ripple
- IEC61000-3-2 Class C line harmonics for LED lighting applications

Delivering leading edge, innovative power solutions for more than 30 years....

Model:GTM962252PWWWVV.V-F

June 2, 2020

- Non-latching (auto-recover) over-temperature protection
- Potentiometer to adjust/trim output voltage
- Custom fan output voltages (5V to 12V), available for main output voltages from 12-24V

Fan Airflow

- For full 225W output power, the fan should provide at least 10CFM in the direction noted below.

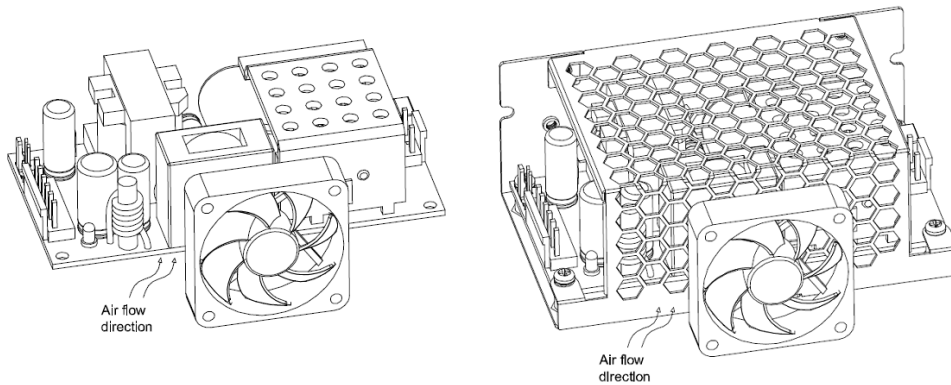

Delivering leading edge, innovative power solutions for more than 30 years....

Model:GTM962252PWWVV.V-F

June 2, 2020

DERATING CURVE

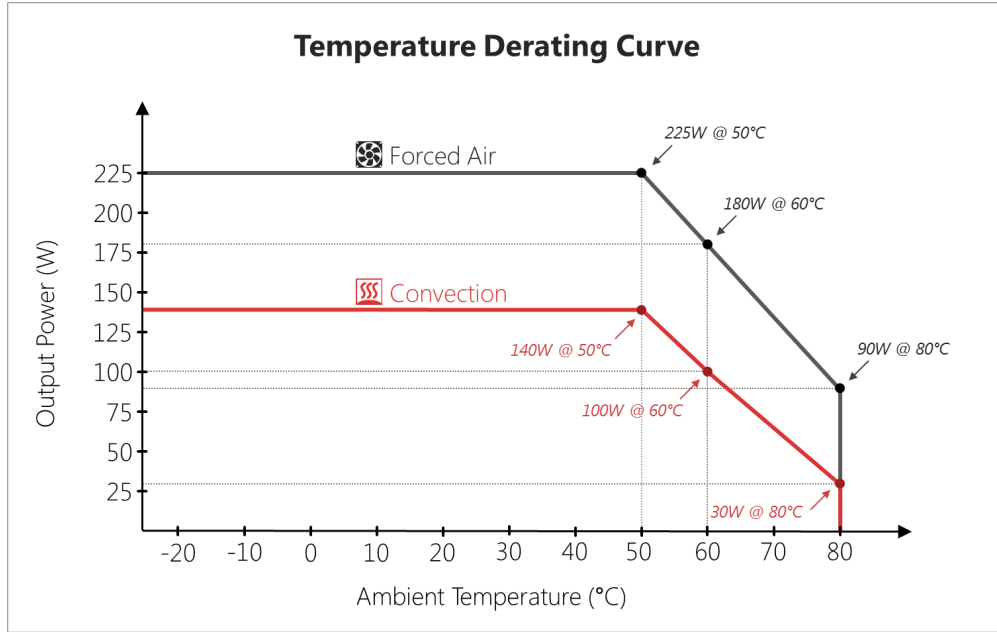

Delivering leading edge, innovative power solutions for more than **30** years....

Model:GTM962252PWWVV.V-F

June 2, 2020

INPUT CONFIGURATION

Description



Optional Input Wiring Kits are available:

PN/Ordering No	Length	End A	End B
C810070M6VAR2(R)	60	IEC 60320 C8	JST VAR-2
C1410070M6VAR2(R)	60	IEC 60320 C13	JST VAR-2
VAR2210070M7VAR2(R)	73	JST VAR-2	JST VAR-2









Custom lengths, construction, cable types, ferrites, filters, and termination available upon request.

Delivering leading edge, innovative power solutions for more than **30** years....

Model:GTM962252PWWVV.V-F

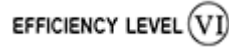
June 2, 2020

Approvals

Logo	Description
	Attention Mark / Refer to operating manual for operating and service instructions
	CHINA SJ/T 11364-2014, China RoHS Chart: http://en.globtek.com/globtek-rohs.php
	Certification # TC RU AR46.B.75423 Custom Union of Russia, Belarus and Kazakhstan
	Indoor Use Only - Mark is on the label or Molded in the case
	Efficiency: complies to section 301 of Energy Independence and Security Act (EISA) complies with Energy Star tier 2 (North America), ECP tier 2 (China), MEPS tier 2 (Australia), Code of Conduct (Europe)
	Morocco SDoC declaration http://www.globtek.info/certs/Morocco%20SDoC%20Declaration/
RoHS	Specifications of directive 2011/65/EU Annex VI (ROHS-2) with amendment 2015/863-EU (ROHS-3) http://www.ce-mark.com/Rohs%20final.pdf
	Ukraine UKRSepro (Document: www.globtek.com/html/iso_certificates/GT_Ukraine.pdf)
	Japan: Voluntary Control Council for Interference (VCCI)
	WEEE: Complies with EU 2012/19/EU (http://ec.europa.eu/environment/waste/weee/index_en.htm) Mark is on the label or Molded in the case